

# OXWIN ES1 Electric Scooter

## ES1 Electric Bike Instruction Manual

Proper use, storage and maintenance can reduce vehicle breakdowns, maintain optimal vehicle performance and extend the service life of the vehicle!

Before riding, please fully understand the performance of this vehicle!

Please read this instruction manual carefully and keep it for future reference!

# DIRECTORY

1.Product Overview	01
2.Operation Instruction	02
3.Parts Description	03
4.Instrument and Combination Switches	05
5.Keys and NFC Cards	07
6.Battery Installation and Use Instructions	09
7.ARE YOU READY !	13
8.FAQ and Troubleshooting	14
9.Basic Parameters	18
10.After-sale service	21

## 1. Product Overview

Thank you for choosing our OXWIN as your electric bicycle brand. We wish you enjoy the comfort and joy it brings you in your long journey in the future!

Our company sincerely hopes that you can provide valuable feedback on the design, manufacturing, quality, and other aspects of this vehicle, and notify us on time in order to improve.

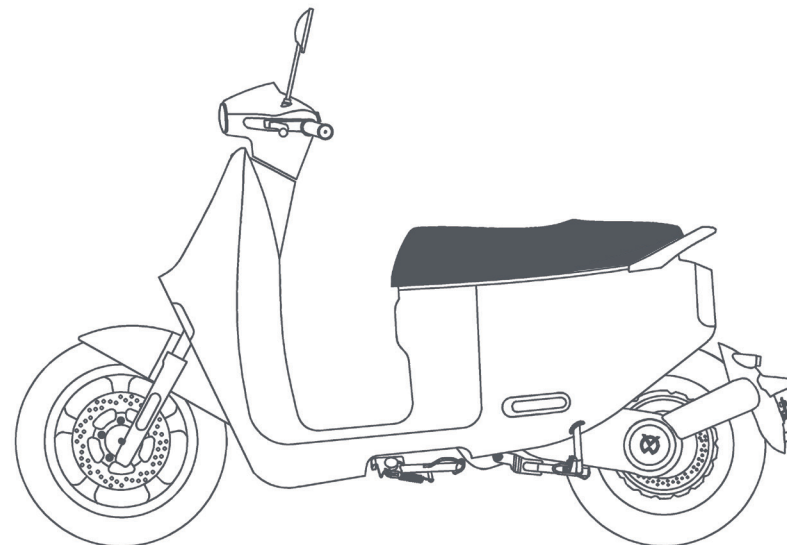

## 2. Operation Instruction

- Please fully understand the performance of this vehicle before use and ride safely.
- Please comply with local traffic regulations and refuse dangerous behaviors such as driving in the wrong direction, driving without following traffic lights, or using mobile phones while cycling.
- Do not disassemble our vehicles or disassemble parts on your own. Unauthorized disassembly and modification of vehicles is not allowed. If you need to replace parts, please purchase them from our company's electric bicycle general agent.

**Please read the following content carefully for your and others' safety :**

### Matters need Attention

- When the road is slippery, the braking distance will be extended, and the distance between vehicles should be appropriately increased to avoid Rear-end collision.
- When wading in water and the water level reaches the the rear wheel hub motor, it will cause a short circuit and damage to the wiring inside our vehicles, please pay attention and do avoid it.

### Precautions for Vehicle Storage

- Please do not charge electric bicycles indoors, try to charge them at an outdoor charging station.
- When replacing the charger, it should match the battery model and try to use the original charger.

## 3. Parts Description

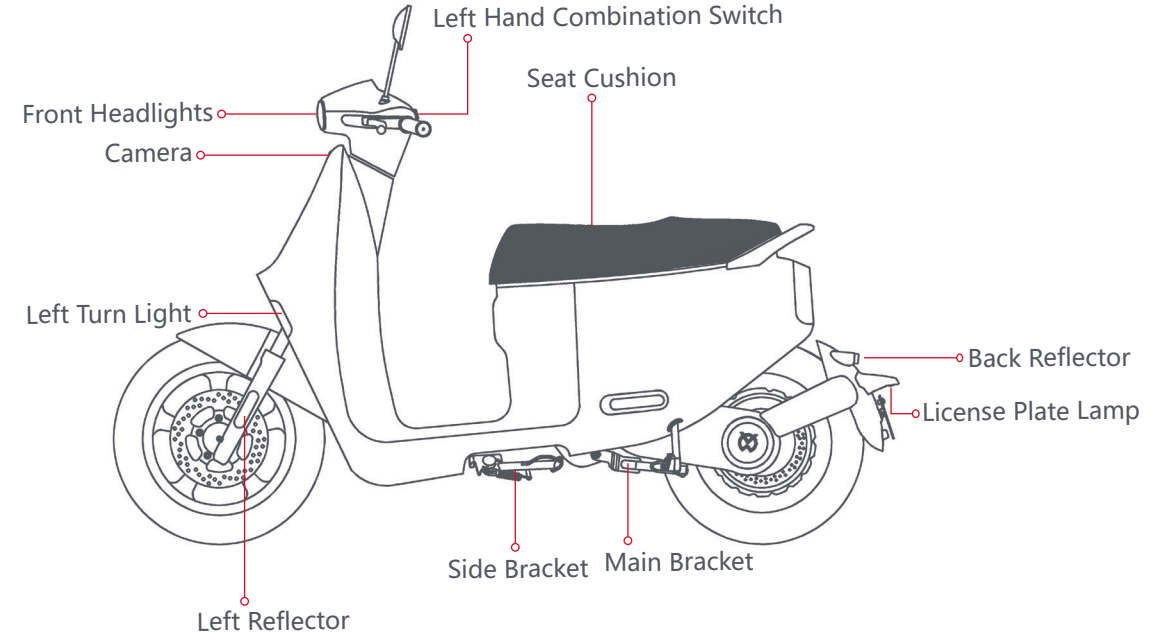

## 4. Instrument and Combination Switches

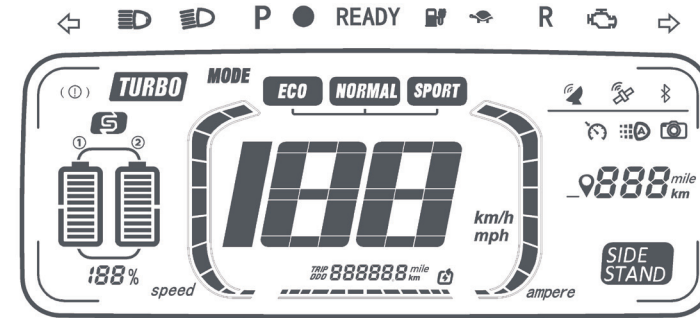
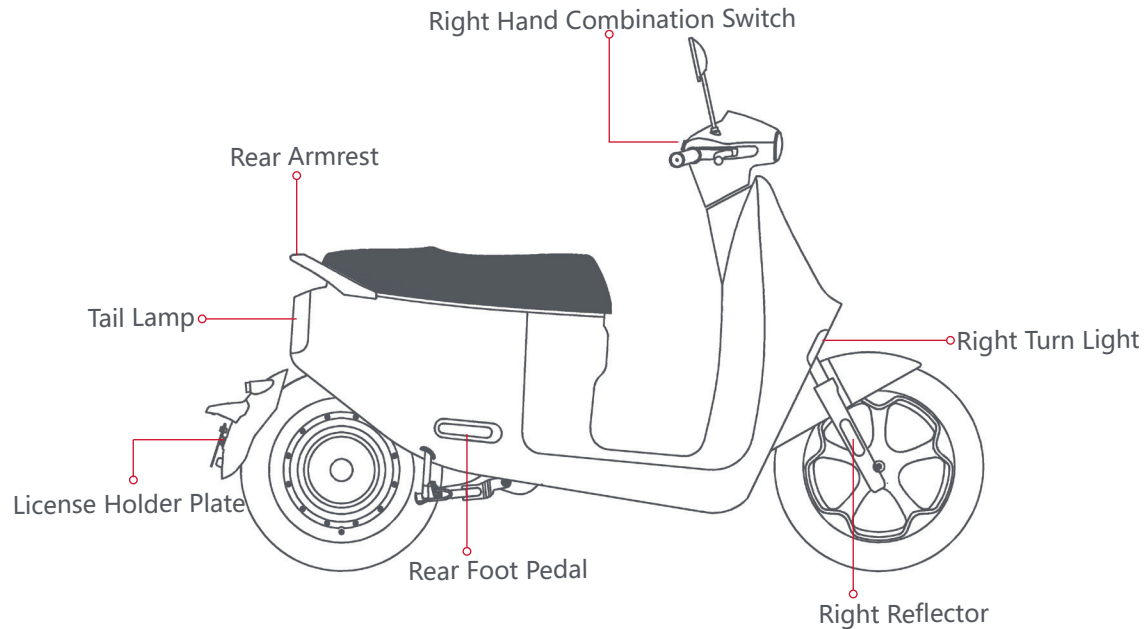

← Left Turn Signal Light	🔋 Charging	🔧 OBD Light work when engine have problem	<b>188</b> <sup>km/h</sup> Speed
→ Right Turn Signal Light	🐢 Turtle slow speed	📶 GSM Signal	(Ⓛ) Signal Light for Brake Turn on when brake
☰ high beam	R Reverse	📶 GPS Signal	<b>TURBO MODE ECO NORMAL SPORT</b> <sup>[1]</sup>
☷ Low beam	🔋 Energy Recovery This light is on when the energy recovery state is in.	📶 Blue Tooth is on	Super acceleration 100km/h(2 battery)   Power saving 45km/h   Normal 60km/h   Sports 80km/h
🅓 Park	🏠 Illuminates when cruise control is turned on	📷 Take Photo	 Power Real-Time Values
● Light perception	☷ Automatic Headlamps	TRIP 888888 mile km Total Mileage Traveled	
READY Ready to go	🅓 Side Bracket Light On when side stand work	📶 Remaining Range	188%

[1] The above speed is the maximum speed of the gear. The super acceleration mode can only be activated when there are dual batteries, and the maximum speed displayed on the meter is 80km/h when there is a single battery.

## Combination Switches Instruction

### Left Hand Combination Switches



#### Low/High Beam

Press to turn on low beam, then press again to switch to high beam;



#### Turn Signal

Press the left button to turn on the left , and press again to cancel;  
Press the right button to turn on the right. turn signal, then press again to cancel.



#### Horn

Press the horn button, the horn will sound, release to stop.



#### Cruise Control

Press to keep the current vehicle speed; to deactivate this function, you can press this button again or accelerate/brake.



#### Multi-Function Buttons

Long press the multifunction key & mode +, to assist go forward ;  
Long press the multifunction key & mode -, to assist back up the vehicle.

### Right Hand Combination Switches



#### Super Acceleration Mode

Press to reach the maximum speed of 100km/h; (Can only be started when there are double batteries.)



#### Gear + and -

Press the left button to decrease the gear;  
Press the right button to increase the gear position.



#### Park Gear

In P gear, simultaneously grip the brake (with a speed of 0)



#### Danger alarm flashing (double flashing)

Press the left and right turn signals to flash and light up, then press again to cancel.



#### Gear Adjust

Short press to switch between TRIP and ODO mileage accumulation; In TRIP mode, press and hold to reset.

## 5. Keys and NFC Cards

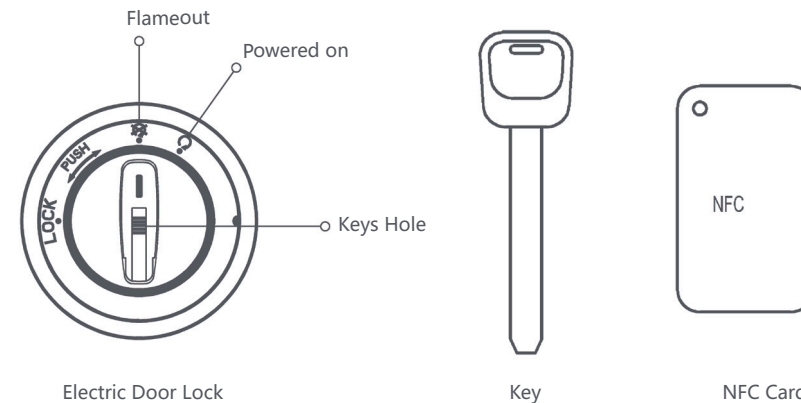

Electric Door Lock

Key

NFC Card

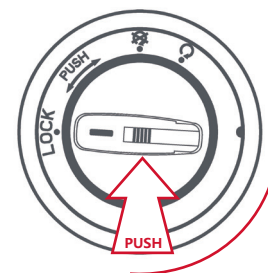

#### Lock Head Lock

Turn the front of the car to its maximum position to the left;  
Then press down and rotate counterclockwise to the "LOCK" position.

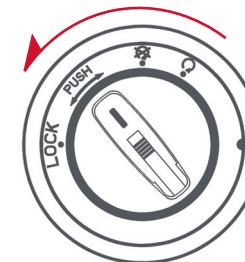

Seat Barrel

#### Open the seat barrel

Insert the key, rotate counterclockwise until you hear a "snap" sound, and the seat barrel opens.

## NFC Cards Use Instruction



### Connect the Vehicle's Power

The NFC sensing area is marked by the right image of Oxwin at the front of the car, located directly below the instrument.

When the vehicle is in a flameout state, place the NFC card on the sensing area until the indicator light comes on. At this time, rotate the power lock clockwise to "power on" and the vehicle power is turned on.

### Power Off

When the vehicle is powered on, rotate the power lock counterclockwise to "turn off" and wait for a few seconds, The vehicle will automatically disconnect the power supply. If you want to cut off the power immediately, you can swipe the NFC card and the sign light will be on immediately turn off and disconnect the power supply.

## 6. Battery Installation and Use Instructions

### Battery Charging

Lift the battery out and insert the charger charging socket into the battery charging port for external charging. At this point, the battery level indicator light will light up and display real-time battery level. When the indicator light is in the full grid state, the charging is complete.

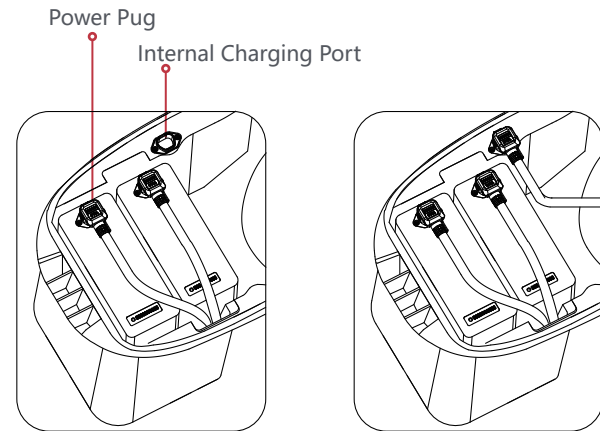
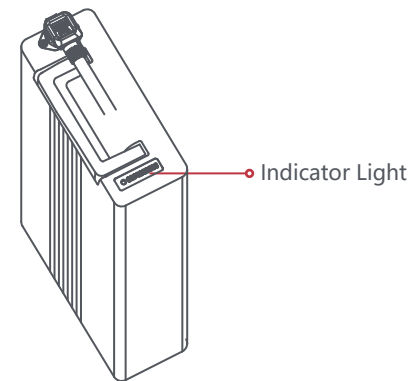

Picture 1

Picture 2

### Battery Installation Diagram

- Open the seat cushion, place the battery in the bucket, and insert the power plug into the battery charging interface. The battery installation is complete, as shown in Picture 1;
- When built-in charging is required, ensure that the battery is installed correctly, insert the charger charging socket into the built-in charging port of the bucket, connect the power, and then the built-in charging can be carried out, as shown in Picture 2.

## Instructions Before Using Batteries

• Please confirm that the battery model is the original vehicle battery before use. Do not use other brands or models of batteries at will.

• Check if the appearance of the battery is intact and ensure that there are no obvious phenomena such as damage, leakage, heating, soaking, and smoking.

• To ensure transportation safety, the factory power of ES1 batteries is around 30%. Due to self-consuming factors such as transportation and storage cycles, it is normal for the battery to be low or empty during first use. Do not worry, just follow the charging instructions for charging.

**Waste batteries cannot be disassembled without authorization and should be handed over to relevant professional departments for recycling and disposal!**

### Usage environment



Please operate Using batteries between -10 °C and 45 °C .



Please avoid soaking the battery with water, beverages, corrosive liquids, etc .



Please avoid keeping the battery lose to heat sources, open flames, flammable and explosive gases (liquids).



Please avoid metal foreign objects entering the battery box.

At low temperatures, the usable capacity of the battery will experience varying degrees of attenuation, with specific reference levels as follows: -70% usable capacity at 10 °C, 85% usable capacity at 0 °C, and 100% usable capacity at 25 °C. **If the battery has odor, heat, deformation, or other abnormal conditions, please stop using it immediately, stay away from the battery, and contact the after-sales department.**

**The battery is not a user repairable component. If any abnormalities occur, please contact the after-sales department for maintenance. Unauthorized disassembly of batteries will not enjoy the three guarantees policy and it may cause the battery to generate heat, smoke, catch fire, or explode.**

## Charging Environment



Please use the original charger provided with the battery for charging, do not charge with other brands charger or other model charger even same brand.



Charge the battery at temperatures ranging from 0°C to 35 °C.

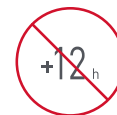

Please do not exceed 12 hours of charging time, Avoid affecting the battery life.

• The battery level increases rapidly in the early stage of charging, but slows down in the later stage. This is a program set for charging safety, which is normal.

• When charging in winter, the outdoor temperature is lower and the environment is lower. At 0°C, the battery will stop charging, which is a normal phenomenon. Please place the battery in a suitable ambient temperature for charging to ensure the charging effect.

• During the charging process, some of the aluminum case chargers we configured have a temperature rise effect, and the surface temperature is relatively high, which is a normal phenomenon. Please rest assured to use them. Please be careful not to be touched by children.

### Precautions for using chargers

• It is strictly prohibited to charge in a confined space, scorching sun, and high temperature environment. It is not allowed to place the charger in a bucket or trunk for charging.

• When charging, insert the battery first and then add the mains power; After sufficient, first cut off the mains power and then unplug the battery plug.

• When the green light is on, the power should be cut off immediately. It is prohibited to connect the charger with no load to the AC power supply for a long time without charging.

• During the charging process, if the indicator light is abnormal, there is an odor, or the charger case is overheated, the charging should be stopped immediately and the charger should be repaired or replaced.

• Do not disassemble or replace the components inside the charger on your own.

• When replacing the charger, it should match the battery model.

## Storage Environment

- If the battery is placed on the vehicle, due to the operation of the vehicle's intelligent system and alarm system, it will constantly consume battery power. After the vehicle is placed for a period of time, it is normal for the instrument panel to display a decrease in battery power. It is normal for the battery to consume around 5% of its power when parked for 8 hours.

- Please maintain the ambient temperature. Store the battery at temperatures ranging from 0°C to 25 °C. Do not store the battery in an environment above 40 °C, as this may cause irreversible capacity degradation. If the vehicle is not used for a long time (such as in winter, summer, or other special circumstances), the battery must be taken out and stored separately, and regularly maintained for charging. Otherwise, it may lead to complete battery depletion and irreversible damage. For such issues, battery failure will not be within the scope of the three guarantees.

- The most suitable storage capacity for batteries is 50%. Long term storage of battery capacity below 10% or above 90% will result in irreversible capacity degradation.

- The self consumption protection mode for safe storage of ES1 batteries, with the following technical standards.

【1】 Long term non use, stored in the vehicle (without unplugging the battery plug), with a maximum safety period of one month, otherwise there may be battery feeding that cannot be repaired.

【2】 Long term non use, battery capacity not less than 50%, stored separately or placed on the vehicle (unplugging the battery plug), with a maximum safety period of 3 months, otherwise there may be irreparable issues with battery feeding.

- Avoid storing batteries in places with a risk of falling, as falling may cause uncontrollable damage inside the battery and may cause leakage, heat, smoke, fire, or explosion.

**Improper use of the above causes battery undervoltage and power feeding, which is not within the scope of three guarantees responsibility.**

## 7. ARE YOU READY?

### A simple three step preparation to complete a comfortable journey.

**First**

Please wear a safety helmet and sit on the vehicle, swipe your NFC card, and turn the power lock to activate the vehicle's power supply.

**Second**

Please fold up the single support/double support and press the right hand combination key "P" while braking to release the lock of gear P. At this time, "READY" will appear in the instrument.

**Third**

Gently twist the throttle handle with your right hand and enjoy your first driving experience with your car.

### Before driving, the vehicle condition should be checked, generally including the following items:

- Instrument: When the vehicle is powered on, please check if the instrument panel displays normally;
- Lights and horns: Check if all lights are in good condition and if the horns are functioning properly ;
- Tires: Check tire pressure and tire wear;
- Steering device: convenience and stability of operation;
- Battery: Open the seat cushion and check if the appearance of the battery is good, ensuring that there are no obvious phenomena such as damage, leakage, heating, soaking in water, and smoking.



## 8. FAQ and Troubleshooting

FAQ Troubleshooting		
Fault phenomenon	Failure cause	Solution
The whole vehicle is out of battery	1.The battery is not connected properly.	1.Please check if the battery main plug is connected in place.
	2. Battery exhausted.	2.Please charge in time.
After turning on the power, the motor does not rotate when the speed control knob is turned	1.The side brace was not retracted	1.Please retract the side brace.
	2. The vehicle is in P gear.	2.Press the brake and press the P gear button at the same time to release the P gear.
	3.The brake lever is not returned to position.	3.Please return the brake lever.
Slow driving speed or short mileage	1.Low battery.	1.Please charge in time.
	2.Tire pressure too low.	2.Please inflate your tires to normal pressure in time before continuing to drive.
	3.The battery is aging or normally scrapped.	3.Please replace the battery in time.
Battery cannot be charged	1.Poor release of charger plug.	1.Please check if the main plug is properly inserted.
	2.Not using the correct charger.	2.Please use the original charger.
	3. The battery is aging or normally scrapped.	3.Please replace the battery in time.
Low beam, high beam, left and right turn signal failure	1.Loose connector.	1.Please check if the connector is connected properly.
	2.Central control (speedometer) malfunction.	2.Replace central control (speedometer).
	3.Damaged lighting fixtures.	3.Replace damaged lighting fixtures.
Speedometer display abnormality	1.Communication failure of central control (speedometer).	1.Please check if the connector is properly connected.
	1.Damaged central control (speedometer).	2.Replace the central control (speedometer).
Rotator failure	1.The speedometer displays E13, but the connector of the rotary lever is loose.	1.Please check if the connector is properly connected.
	1.The instrument displays E13, the handle is damaged	2.Replace the handle.
Motor does not rotate	1.Motor Hdll fault.	1.Replace the spare Hall of the motor.
	2.The motor is flooded or damaged.	2.Replacing the motor.

Battery troubleshooting		
Fault phenomenon	Failure cause	Solution
Battery is power off and the vehicle cannot start.	Battery exhausted.	Please charge the battery.
Battery cannot be charged.	The battery is under voltage for too long, causing he battery to become unusable.	Please contact after-sales service or replace the battery.
When driving with low battery, the battery loses power.	Battery exhausted or low voltage protection, ormal phenomenon.	Please charge the battery.

Fault code definition		
Fault codes	Failure cause	Solution
Speedometer display E11	Motor failure	Power off and restart. If the status persists, please contact after-sales or designated authorized service outlets.
Speedometer display E12	Motor Hall fault	1.Power off and restart. If the status remains, check the throttle handle, motor, and controller connection cables; 2. Replace the spare Hall of the motor. If the spare all is already used, please contact after-sales or designated authorized service outlets.
Speedometer display E13	Rotating handle fault	Power off and restart. If the status remains, check the throttle handle, motor, and controller connection cables.
Speedometer display E14	Brake failure	Please check the brake lever, motor controller and related connections.
Speedometer display E15	Controller failure	Power off and restart. If the status remains, connect the controller to the cable; please contact after-sales or esignated authorized service outlets.
Speedometer display E16	Controller undervoltage	Power off and restart. If the status persists, please contact after-sales or designated authorized service outlets.
Speedometer display E17	Controller overvoltage	Power off and restart. If the status persists, please contact after-sales or designated authorized service outlets.
Speedometer display E18	Controller overcurrent	Power off and restart. If the status persists, please contact after-sales or designated authorized service outlets.
Speedometer display E19	Controller over temperature	Power off and restart. If the status persists, please contact after-sales or designated authorized service outlets.
Speedometer display E20	Motor overtemperature	Power off and restart. If the status persists, please contact after-sales or designated authorized service outlets.
Speedometer display E41	Battery discharge MOS tube damaged	Please contact after-sales or designated authorized service outlets.
Speedometer display E42	Battery charging MOS tube is damaged	Please contact after-sales or designated authorized service outlets.

Fault phenomenon	Failure cause	Solution
Speedometer display E43	Battery short circuit protection	Power off and restart. If the status persists, please contact after-sales or designated authorized service outlets.
Speedometer display E44	Battery cell voltage failure	Please contact after-sales or designated authorized service outlets.
Speedometer display E45	Battery cell balancing failure	Please contact after-sales or designated authorized service outlets.
Speedometer display E46	Battery undervoltage (discharge cutoff)	Please contact after-sales or designated authorized service outlets to activate with a dedicated charger.
Speedometer display E47	Battery discharge at low temperature	Low temperature protection.
Speedometer display E48	Battery discharge at high temperature	Wait until the battery cools down before using it.
Speedometer display E49	Battery charging low temperature	Low temperature protection.
Speedometer display E50	Battery charging high temperature	Wait until the battery cools down before using it.
Speedometer display E51	Battery discharge overcurrent warning	Power off and restart. If the status persists, please contact after-sales or designated authorized service outlets.
Speedometer display E52	Battery charging overcurrent warning	Power off and restart. If the status persists, please contact after-sales or designated authorized service outlets.
Speedometer display E53	Communication interruption between BMS and controller	Power off and restart. If the status persists, please contact after-sales or designated authorized service outlets.
Speedometer display E54	Battery core sampling line breakage protection	Please contact after-sales or designated authorized service outlets.
Speedometer display E81	Controller communication abnormality	Power off and restart. If the status persists, please contact after-sales or designated authorized service outlets.
Speedometer display E82	BMS communication abnormality	Power off and restart. If the status persists, please contact after-sales or designated authorized service outlets.
Speedometer display E83	SIM card recognition failed	Power off and restart. If the status persists, please contact after-sales or designated authorized service outlets.
Speedometer display E84	T-BOX is disconnected or in arrears	
Speedometer display E85	T-BOX wireless signal weak	
Speedometer display E86	Remote lock vehicle	

## 9. Basic parameters

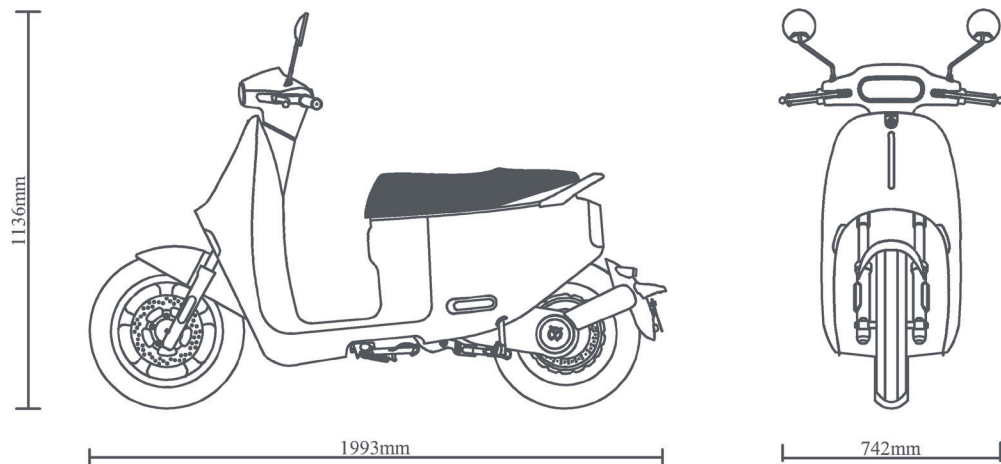

## Vehicle Main Parameters

No.	Description	Parameters
A1	Vehicle main parameters	
A1.1	External dimensions: long × wide × high	1993mm×742mm×1136mm
A1.2	Seat height	780mm
A1.3	Motor	Single arm hub motor
A1.4	Controller	FOC
A1.5	Battery	72v,30Ah (can choose 60Ah battery, max endurance mileage 140km)
A2	Appearance dimensions	
A2.1	Front hub	MT 2.15×14
A2.2	Rear hub	MT 2.75×13
A2.3	Front tire size	100/80-14
A2.4	Rear tire size	120/70-13
A2.5	Wheelbase	1325 mm
A2.6	Ground clearance	150 mm
A2.7	Technically permissible maximum load	205kg
A2.8	Wheel hub material	Aluminum alloy
A3	Technical specifications	
A3.1	Rated power	5000w
A3.2	Peak power	9000w
A3.3	Top speed	95 KM/H
A3.4	Endurance mileage	1 battery 70km; 2 batteries 140km (tested according to EEC)
A3.5	Operation life	About 800 times (Battery capacity>70% )
A3.6	Brake system	CBS

## Electrical Diagrams

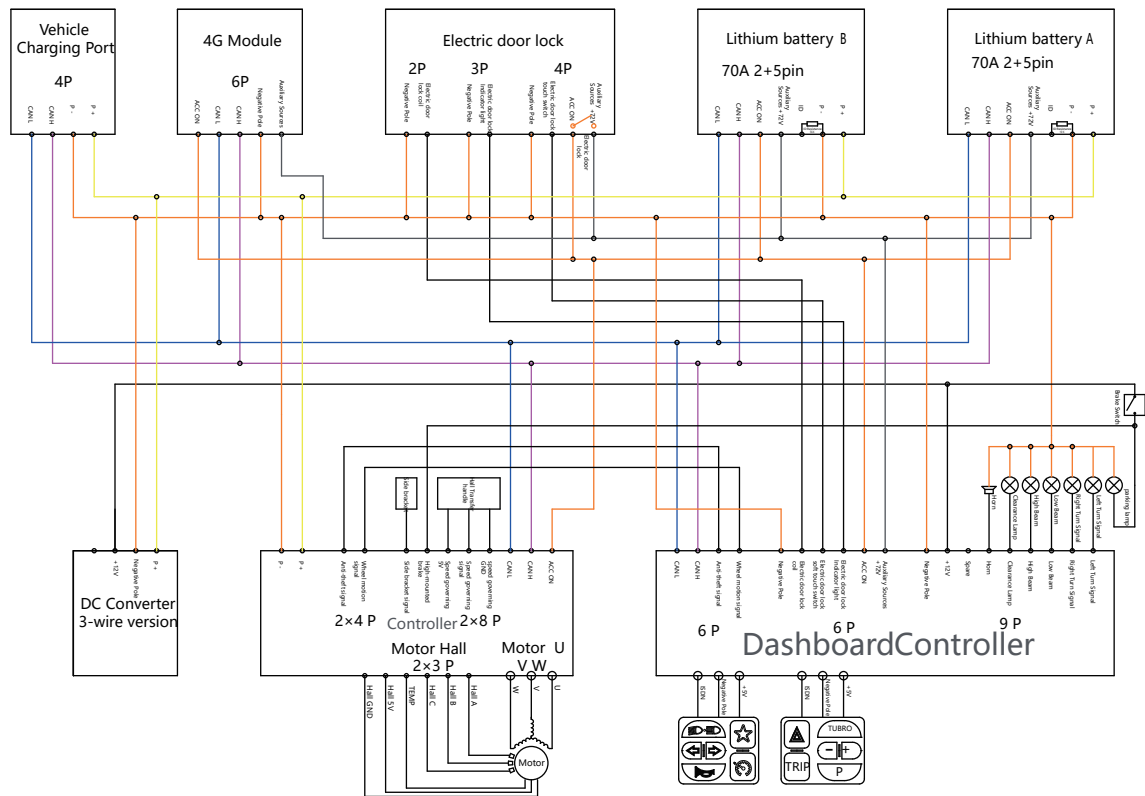

## 10. After-sale service

A three guarantees standard			
Accessories	Parts name	Three guarantees period	Quality assurance instructions
Lithium battery	Lithium battery	24 Months Change the battery within the first 6 months or 5,000 km; Change the battery or repair in the next 18 months	1. After the lithium battery is fully charged in the specified usage environment, if there are voltage abnormalities, inability to charge/discharge, and less than 60% capacity faults during use without external impact are given three guarantees of service.(The rechargeable ambient temperature range of lithium battery is 0°C -40°C , and the ambient temperature range of lithium battery is -15°C -45°C . In the case of low temperature, the capacity of lithium battery will decline to different degrees. The specific reference degree is: -10°C available capacity is 70%, 0°C 85%, 25 °C 100%) 2. 24 months or 20,000 kilometers, subject to first.(Change the lithium battery within the first 6 months or 5000km; within the last 18 months) 3. The three -guarantee period of the replaced lithium battery pack is calculated according to the remaining date of the original battery purchase. 4. The parts are only guaranteed in the case of performance failure, and the appearance is not bad.
Body parts	Frame	36 Months	Natural cracking, dewelding, fracture and deformation.
Motor	Motor	24 Months	1. The coil phase deficiency, burning , magnetic steel demagnetization, falling off and other quality problems caused by external forces; 2. The parts are limited to the performance failure of the warranty, the appearance of the case is not warranty.
Charger	Charger	18 Months	1. Performance faults that occur due to product reasons or quality problems that cannot be repaired. 2. The parts are limited to the performance failure of the warranty, the appearance of the case is not warranty.

A three guarantees standard			
Accessories	Parts name	Three guarantees period	Quality assurance instructions
Body parts	Vehicle body parts: direction handle, direction column, rear flat fork, front aluminum wheel, rear aluminum wheel, front and rear shock absorption, disc brake system, main bracket, side bracket, front bracket, rear shelf, rear fender bracket Electrical parts: headlights, turn signal, rear taillight, license plate light, profile light, instrument, central control, combination switch, set lock, USB charging port, DC converter.	12 Months or 12,000 KM	1. Performance failures or irreparable quality problems due to product reasons.
Quick -wear parts	Quick -wear parts: plastic parts paint, rearview mirror, brake shoe block, tires, charging port components, cable, power cable plug, appearance parts, PP parts and other appearance parts not included in the above items.	Not covered by the warranty	Quick -wear parts are not under warranty
B non -three guarantees standard			
If the time limit and scope specified in the "Three Guarantees" are exceeded, it shall be deemed as exceeding the "Three Guarantees" service.			
Product malfunction or damage caused by users not using, driving, maintaining, and adjusting the product correctly according to the instructions.			
Damage or natural loss caused by rain, snow, snow, smoke, corrosion of drugs and chemicals, as well as failure or damage caused by force majeure (including but not limited to earthquake, typhoon, fire, flood, social events, mass incidents, violent crimes, etc.).			
Users modify, disassemble, repair, and damage the product as a whole and parts of the normal use of the state.			
The user does not carry out normal use and maintenance of the battery, such as not using the vehicle for a long time, and not charging in time, resulting in the battery loss and undervoltage, which cannot be repaired.			
Product failure or damage caused by human factors such as collision, fall, overloading and speeding in the process of driving.			
Users alter, tear up or change the three guarantees of service date of products and parts without authorization.			
No valid three guarantees voucher, invoice, or not consistent with the product.			
Non -product itself quality problems, such as users are not satisfied with the appearance and color of the product.			
Advertising and promotion, free goods, sound size, tactile hard and soft and other artificial feeling items.			